

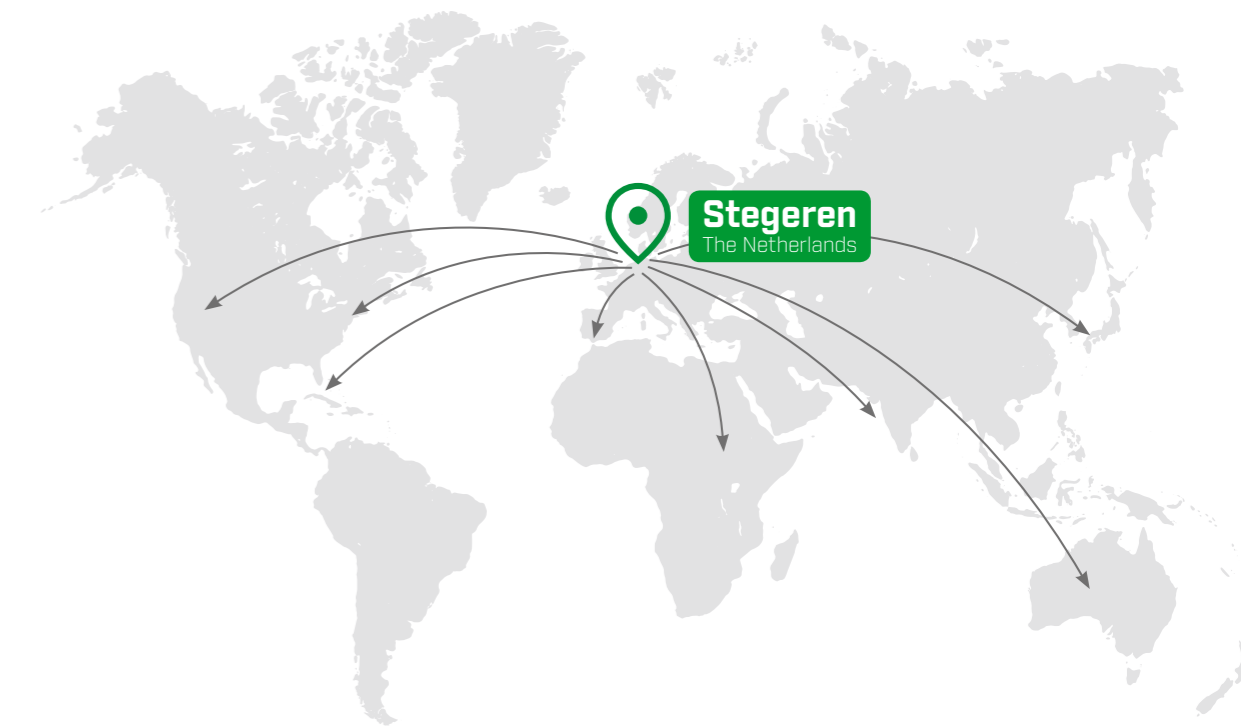

**Chippers, Broyeurs, Affineurs  
Robustes pour usage industriel**

# About us

Our company's roots are deeply anchored in the agricultural and forestry world since year 1986. We are working together with Farmi Forest and Junkkari Finland for the supply and distribution of PTO disc chippers since year 1999. We are sole agent in Europe for all Precision Husky sawmill equipment and chippers and grinders since 2004. We do rotary debarkers for Europe territory and since 2000 we did the distribution and selling of Woodsman chippers in Europe till it was aquired by Terex. Parallel we began with design and production of our own Europe Chippers. Right now we have a full line of Europe Chippers, Europe Grinders and Europe Shredders, from 14 to 1000 HP that take from 140 to 1000 mm diameter logs.



## Our mission

Based on agricultural principles, smart innovations and listening to our clients worldwide, we deliver custom made forestry equipment for industrial use on all 5 continents.



## Sales conversation

We ask about the material going in, and what capacity and size you expect to come out. We build a custom made machine performing exactly according to your expectations.

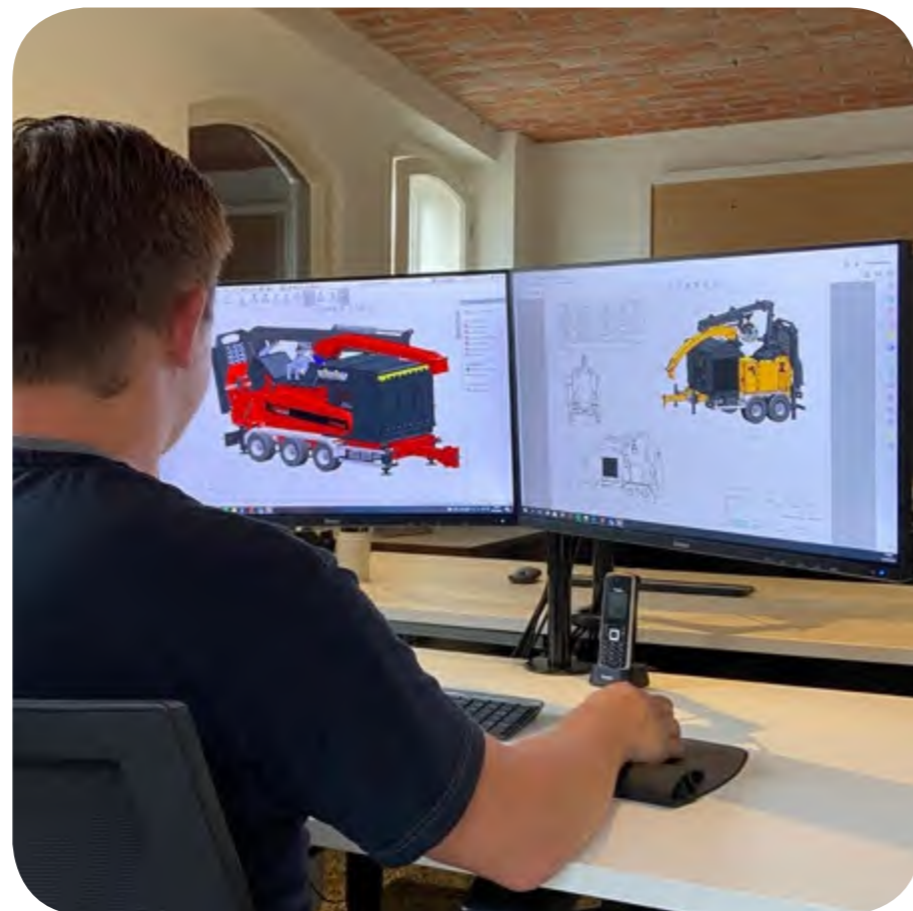

## Engineering

We build modular like LEGO. You can add general options, power options, transport options and crane options on any basic unit for any Europe Chipper, Europe Grinder or Europe Shredder.



## Construction

We use the highest quality steel such as S350 and Strenx 700 performance steel, doing 700 KG/mm<sup>2</sup> according to EN 10149-2.



## Commissioning

World wide, we visit you at your place to instruct your workers and to put your machine into operation.



# CC 140

## Compact Chipper on tracks

This Compact Chipper is Powered by a Subaru petrol engine. The chipper drum has 2 Widia knives 63 HRC and 8 hammers. Hydraulic powerfeed and 3 screens possible for making microchips and mulch.



# CC 140

 Our wood chippers are fully customizable

### standard:

- infeed opening 200 x 140 mm / 7,8 x 5,5"
- weight 395 kg
- LxWxH: 195 x 75 x 138 cm
- 16 cm wide rubber tracks
- 2x speed forward/1x reverse
- discharge height 1380 mm and only 750 mm wide
- 2 widia knives 63 rockwell + 8 hammers

### optional:

- electric starter
- electrical hours counter
- automatic no stress
- capacity 5 m<sup>3</sup>/hour
- fuel tank 6,8 liters
- adjustable chip size for micro chips up to G30
- electric hydraulic operated

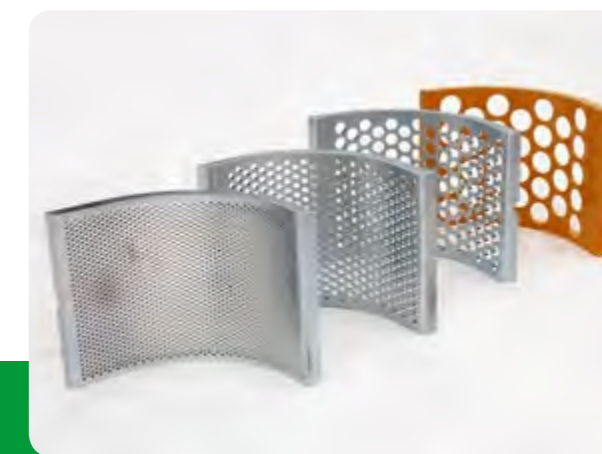

up to  
5 m<sup>3</sup>/h



up to  
14 hp



logs up to  
140 mm

# DC 285

## Starter model Disc Chipper

Disc Chipper for high quality uniform wood chips. PTO, trailer or stationary electro. DC 285 electro is for "industrial" chip production 3-20 mm. 45° infeed angle = self-feeding.



# DC 285

 Our wood chippers are fully customizable

### standard:

- infeed opening 260 x 260 mm / 10 x 10"
- weight 950 kg
- automatic no stress
- 4 knives + 2 counter knives
- RPM 540 - 1000
- three-point hitch
- on board hydraulics + powerfeed
- electric hydraulic operated

### optional:

- brush knives 4x
- stationary + electro
- trailer + diesel 70 hp
- screen for micro chips
- crane infeed
- walterscheid PTO free running + overload protection
- chute extension



up to  
25 m<sup>3</sup>/h



50 -  
100 hp



logs up to  
260 mm

# DC 385

## Professional Disc Chipper

Our Disc Chippers are famous for high quality uniform size wood chips. Sharp knives give the lowest needed horse power. Self feeding 45° infeed angle.



# DC 385

 Our wood chippers are fully customizable

### standard:

- infeed opening 350 x 400 mm / 14 x 16"
- weight 3500 kg
- automatic no stress + powerfeed for toproller
- 4 knives + 2 counter knives
- RPM 540-1000
- on board hydraulic system
- 3 point hitch
- electric hydraulic operated

### optional:

- brush knives 4x
- trailer + diesel 200hp
- stationary + electro 150 kw
- crane mounting plate + crane
- walterscheid PTO free running + overload protection
- closed hydraulic infeed chain or bottom roller
- chute extension



up to  
60 m<sup>3</sup>/h



100 -  
200 hp



logs up to  
350 mm



# EC 640

## The easy transporter

You will not find any better lightweight wood chipper including galvanized tandem chassis, push brakes, 200 HP engine, crane EFC 2050 with total weight 3500 kg, average fuel 15200 L diesel over 2000 hours.



# EC 640

 Our wood chippers are fully customizable

### standard:

- infeed opening 600 x 400 mm / 24 x 16"
- galvanized tandem chassis 2x 2500 kg + push brakes
- Strenx 700 steel: 70 kg per mm<sup>2</sup>
- 200 hp Cat, Perkins or 250 hp Deutz engine
- wear plates under drum and in the pipe
- mechanical clutch WPT
- electric hydraulic operated manual override
- hydraulic top roller + reduction gear + downpressure

### optional:

- Europe controller with vario chip + constant chip
- remote control with joysticks for chipper, crane and engine
- German TÜV certificate and road legal in European Union
- load sensing oil pump 100 liters/minute
- action/warning plates for traffic
- 2x hydraulic legs replacing mechanical legs
- hydraulic bottom infeed roller + reduction gear



up to  
70 m<sup>3</sup>/h



200 -  
250 hp



logs up to  
400 mm



# EC 850

## Most economical chipper

The EC 850 is the perfect combination of compact design and maximum capacity up to 100 m<sup>3</sup>/h with 300 hp diesel or electric power.



# EC 850

 Our wood chippers are fully customizable

### standard:

- infeed opening 800 x 500 / 32 x 20"
- weight 4535 kg / 10.000 lbs \*
- 250 hp Deutz or 300 hp Cat C71
- 3 staggered knives + 1 counter knife
- tandem chassis + (hydraulic) push brakes
- toproller + reduction gear + downpressure
- mechanical clutch WPT

*\*chipper + engine + tandem chassis*

### optional:

- aggressive bottom infeed roller + reduction gear
- tracks or electric stationair
- hydraulic infeed table foldable + open infeed chain
- load sensing, oil pump + oil cooler
- Flexxaire/Cleanfix self cleaning radiator
- crane EFC 4070 4 tonnes + 7 meters
- German TÜV certificate and road legal in European Union
- Europe controller with "vario chip" and "constant chip"

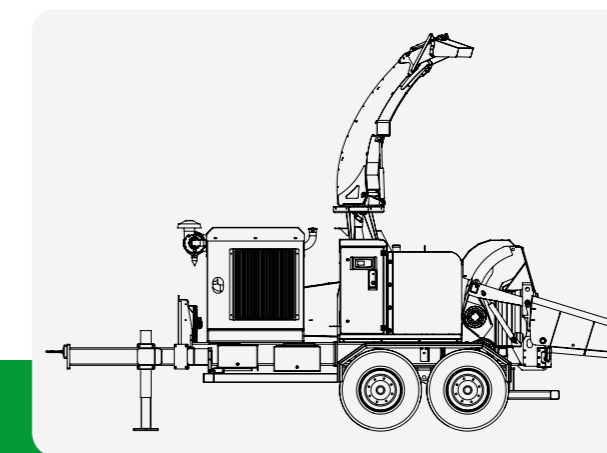

up to  
100 m<sup>3</sup>/h



up to  
300 hp



logs up to  
500 mm





# EC 1060

## The allrounder

Our EC 1060 is our best selling Europe Chipper with a 456 hp Cat engine or 550 hp Deutz/Liebherr engine. This chipper does up to 120-150 m<sup>3</sup>/h. Chip size G30/G50/G100/G120



# EC 1060

 Our wood chippers are fully customizable

### standard:

- infeed opening 1000 x 625 mm / 40 x 25"
- weight 11,000 kg
- screens 70/90/110 mm
- discharge height with pipe 4,9 m 400° rotating
- diesel/electric/PTO possible 456-550 hp Cat or Deutz
- hydraulic legs 4x
- average fuel consumption cat engine C9.3B 456 hp: 4500 hours = 25080 gallons = 94.927 liter

### optional:

- aggressive vertical infeed rollers plus reduction gears
- self-cleaning radiator for oil, water and air
- full radio remote control for chipper, crane and engine
- 3x open infeed chain plus hydraulic infeed table foldable
- tracks 15 tons capacity, LxW 2500x500 mm
- tandem chassis 80 km/h German TÜV certificate
- crane EFC 8095 8 tonnes 9.5 meter reach
- Europe controller with "vario chip" and "constant chip"



up to  
150 m<sup>3</sup>/h



up to  
550 hp



logs up to  
600 mm



# EC 1175

## Maximum capacity

The EC 1175 has a capacity up to 200 m<sup>3</sup>/h for industrial use. Massive 20 tonnes construction on truck, trailer, tracks, hooklift or stationary electric. Engines 600-800 hp from Cat C15/C18 or Deutz



# EC 1175

 Our wood chippers are fully customizable

### standard:

- infeed opening 1100 x 750 / 44 x 30" \*
- weight 20.000 kg
- screens 70/90/110
- discharge height 5.5 meters 400° rotating
- double cut drum with 6 knives / single cut 3 knives
- Cat C15 600 hp or Cat C18 800 hp engine
- truck, trailer, hooklift or container twist lock chassis

*\*measured between the centre of both vertical infeed rollers*

### optional:

- full radio remote control for chipper, engine and crane
- hydraulic foldable infeed table
- tracks 60 cm wide 30 tonnes capacity, 3 meters long
- aggressive vertical infeed rollers + reduction gears
- crane EFC 1010: 10 tonnes + 10 meters reach
- self cleaning radiators
- Europe controller with "vario chip" and "constant chip"
- tandem or tridem chassis + air brakes



up to  
200 m<sup>3</sup>/h



600 -  
800 hp



logs up to  
750 mm



# EC 1290

## Top of the bill

Biggest serial build wood chipper from the Netherlands. Venturi system, no power consumption for discharge, no blower, no paddles, no dust production, no damaged woodchips.



# EC 1290

 Our wood chippers are fully customizable

### standard:

- infeed opening 1200 x 900 / 47 x 35"
- total weight 26.000 kg including crane and tridem
- compact design
- LxWxH: 8,4 x 2,5 x 4,0 meters
- 800 hp Cat C18 or 900 hp Deutz TCD 18L6
- discharge height 5.5 meters 400 degrees rotating
- mechanical override for all hydraulics

### optional:

- Europe controller with vario chip + constant chip
- full radio remote + joysticks for chipper, crane and tracks
- screens 90 - 110 - 130 mm
- aggressive side infeed rollers + reduction gears
- tracks 30 tonnes 60 cm wide + rubber pads 3500 mm
- tridem chassis 3 x 9 tonnes + air brakes
- crane 10 tonnes 10 meter
- German TÜV certificate and road legal in European Union



up to 250 m<sup>3</sup>/h



800 - 900 hp



logs up to 900 mm



# Europe Grinders

From the agricultural world we take bottom infeed, overtop rotor with hammers, nitrided wear plates, integrated screen and bottom discharge. Friction between the hammers and wear plates opens all the fibres.



## EG 415/830/1250/1660

 Our wood grinders are fully customizable

- output determined by: size of screens, RPM overtop rotor and speed of infeed augers
- the latest load-sensing software
- Europe Grinders open the fibres of the wood chips to make the drying process more efficient
- input from soaking wet to powder dry: the grinder never blocks

	EG 415	EG 830	EG 1250	EG 1660
production	15 m <sup>3</sup> /h = 3000 kg/h	30 m <sup>3</sup> /h = 6000 kg/h	45 m <sup>3</sup> /h = 9.000 kg/h	60 m <sup>3</sup> /h = 12.000 kg/h
weight rotor	1000 kg	1500 kg	2000 kg	2500 kg
width	415	830	1270	1270
diameter	1200	1200	1200	1200
hammers steel 600	120 + reinforced	240 + reinforced	360 + reinforced	480 + reinforced
plates	18 + nitrided	36 + nitrided	54 + nitrided	72 + nitrided
power electric	90 kw	160 kw	250 kw	315 kw
infeed augers	1x 3 kw	2x 3 kw	3x 3 kw	4x 3 kw
chassis + dampers	yes	yes	yes	yes
stainless steel bunker	yes 2000 x 1000	yes 2000 x 1000	yes 2500 x 1000	yes 2500 x 1000
max size infeed	60x30x20 mm	60x30x20 mm	60x30x20 mm	60x30x20 mm



15- 60  
m<sup>3</sup>/h



90-  
300 kw



input  
max G100



# Europe Shredders

Universal mobile slow speed two shaft shredder  
 For concrete waste, waste wood, green wood, industrial waste, household waste, old tires, railway sleepers



## ES 680/750/900

 Our wood shredders are fully customizable

- quick change cassettes for changing rotors
- four different programs for concrete, steel, wood and compost possible
- star screen under discharge possible
- slide in screen under rotors possible
- maximum engine acces
- asynchrone rotor drive
- radio remote control for shredder and tracks

	ES 680	ES 750	ES 900
infeed	1360 x 1360 mm	1500 x 1500 mm	1800 x 1800 mm
Volvo/Cat/Deutz engine	200 hp	300 hp	400 hp
radio remote	yes	yes	yes
shafts	2	2	2
conveyor	height 3,2	height 3,7	height 4,2
overbelt magnet	standard	standard	standard
tracks 2,5 km/h	2700 x 400 mm	3000 x 500 mm	3500 x 600 mm
total weight	15 tonnes	20 tonnes	25 tonnes
option star screen	possible	possible	possible



70 - 200  
m<sup>3</sup>/h



200 -  
400 hp



trunks up to  
1 - 2 m Ø



CC 140



DC 285



DC 385



ES 680



ES 750



ES 900



EG 415



EG 830



EG 1250



EG 1660



EC 640

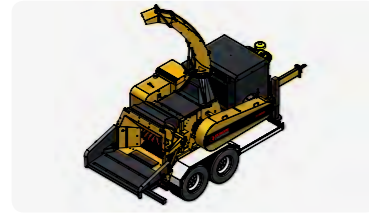

EC 850



EC 1060



EC 1175



EC 1290

# Overview

Europe Chippers	max Ø	HP up to	capacity up to	infeed opening	output ö-norm M133
CC 140	14 cm	14	5 m³/h	200 x 140 mm	G30
DC 285	26 cm	100	30 m³/h	260 x 260 mm	G30/G50
DC 385	35 cm	200	60 m³/h	350 x 400 mm	G30/G50/G100
EC 640	40 cm	250	70 m³/h	600 x 400 mm	G30/G50/G100
EC 850	50 cm	300	100 m³/h	800 x 500 mm	G30/G50/G100
EC 1060	60 cm	550	150 m³/h	1000 x 600 mm	G30/G50/G100
EC 1175	75 cm	800	200 m³/h	1100 x 750 mm	G30/G50/G100/G120
EC 1290	90 cm	900	250+ m³/h	1200 x 900 mm	G30/G50/G100/G120

Europe Grinders	max size input	kw	capacity up to	infeed opening	output
EG 415	6 x 3 x 2 cm	90 kw	15 m³/h	60 x 410 mm	
EG 830	6 x 3 x 2 cm	160 kw	30 m³/h	60 x 830 mm	
EG 1250	6 x 3 x 2 cm	250 kw	45 m³/h	60 x 1250 mm	
EG 1660	6 x 3 x 2 cm	300 kw	60 m³/h	60 x 1660 mm	

Europe Shredders	max Ø rotor	HP	capacity up to	infeed opening	output
ES 680	2x 68 cm	200	depends on input material	1360 x 1360 mm	
ES 750	2x 75 cm	300	depends on input material	1500 x 1500 mm	
ES 900	2x 90 cm	400	depends on input material	1800 x 1800 mm	

# Preferred partners & dealership



## Precision Husky

**Europe Forestry is sole agent of Precision Husky for the total European territory.** Precision Husky is market leader for professional industrial Sawmill Equipment. Precision Husky offers a wide range of stationary and mobile wood chippers, grinders and accessoires, as disc chippers, screens, conveyors, debarkers, log decks and so on. Up to 350 tonnes per hour. All Precision Husky machines come with European homologation and CE documents.



## AJP

**AJP Rotary log debarkers extreme heavy duty mobile diesel or stationary electric.** Rotary debarkers have 2/3/4 rotors with optimal contact between debarking kickers and log surface over a 3-9 meter length. The system is designed to debark various types and diameters of wood year-round. Capacity up to 40-60 tonnes/hour, based on fresh wood. With log diameters between 7 and 75 mm. Less than 1% bark. European Homologation.



## Barber

**The Barber Surf Rake is the world's most popular beach cleaning machine and is used in over 90 countries and 5 continents with capacity up to 3,5 ha per hour.** As a tractor-towed machine, it is ideal for cleaning every size beach up to 35000 m<sup>2</sup>/h. Barber beach cleaning machines are effective in removing beach pollution such as seaweed, dead fish, glass, syringes, plastic, cans, cigarettes, shells, stone, wood, oil and tar balls. The big difference with all our competitors is that Barber only does the picking. There is no need for screening, so we can work in rain and snow. We need 50% less energy for high speeds beach cleaning up to 20 km/h.

# Follow us online!

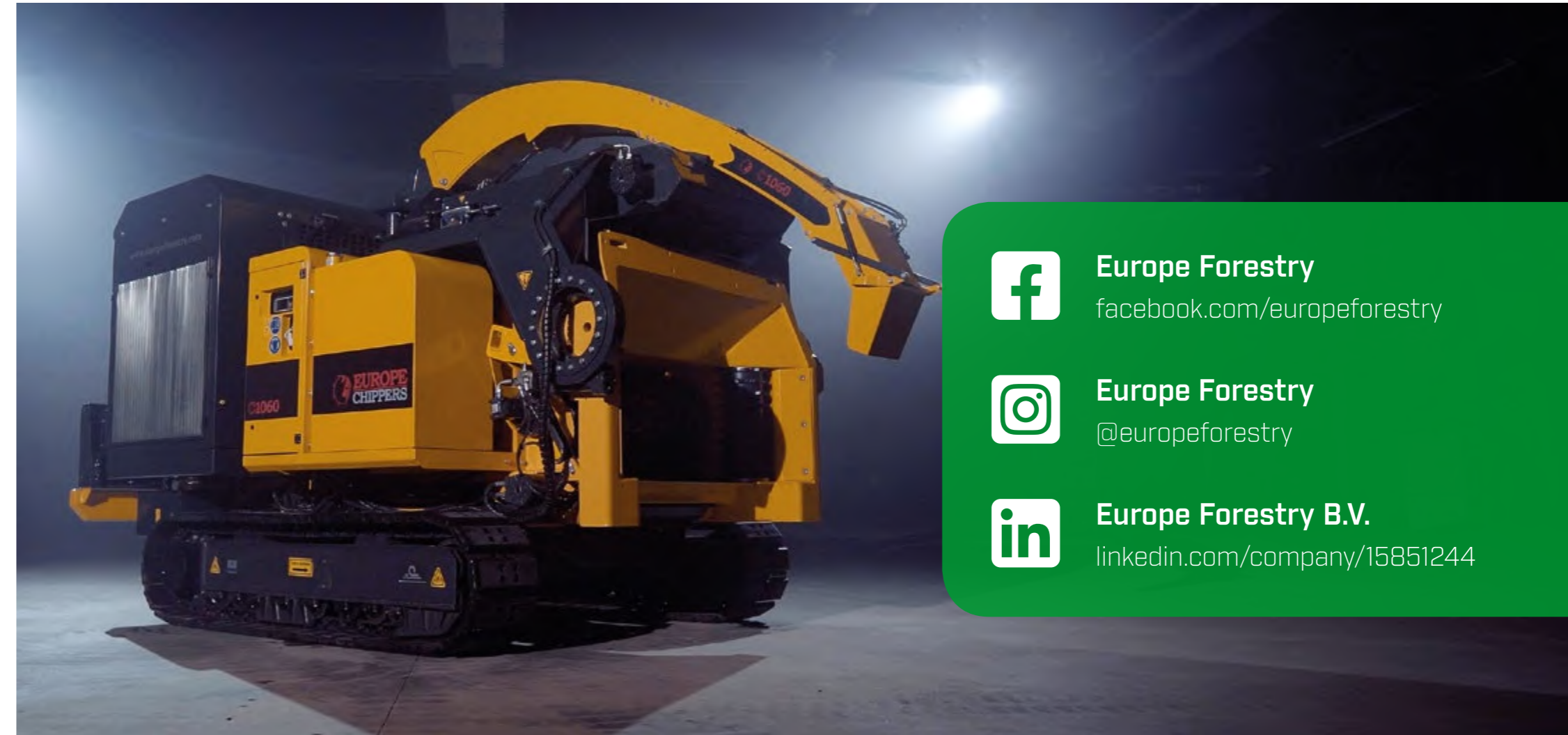

**Europe Forestry**  
[facebook.com/europeforestry](https://facebook.com/europeforestry)



**Europe Forestry**  
[@europeforestry](https://@europeforestry)



**Europe Forestry B.V.**  
[linkedin.com/company/15851244](https://linkedin.com/company/15851244)



# Etes-vous intéressés ?

N'hésitez pas à nous contacter pour un conseil ou un devis

 +31 529 46 12 66

 [info@europeforestry.com](mailto:info@europeforestry.com)

 [europeforestry.com](http://europeforestry.com)

 Stegerdijk 13  
7737 PT Stegeren  
The Netherlands



5 Rue de l'Industrie  
77173 CHEVRY COSSIGNY  
Tél 01 64 05 45 15—06 07 64 14 16  
[www.vercom.fr](http://www.vercom.fr)  
[marc.brehm@vercom.fr](mailto:marc.brehm@vercom.fr)